

K735

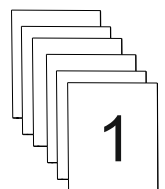

342 x 278 mm

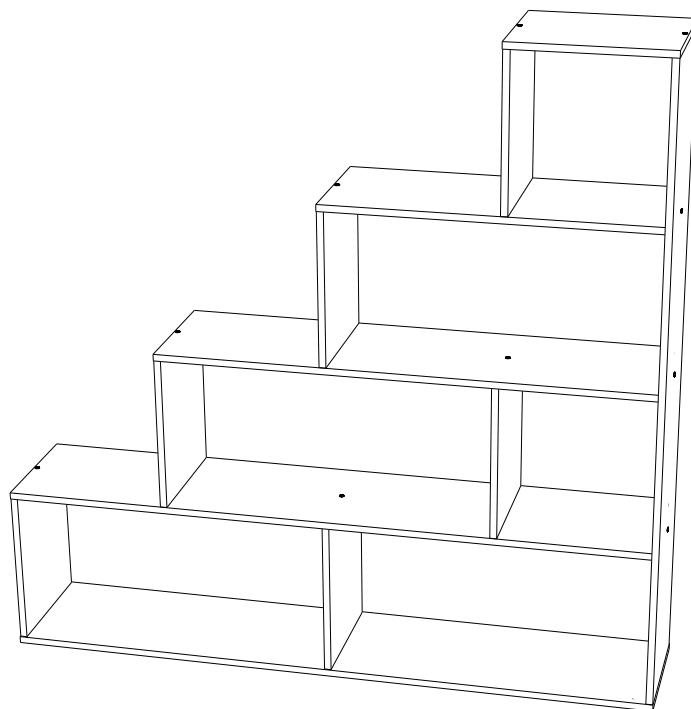
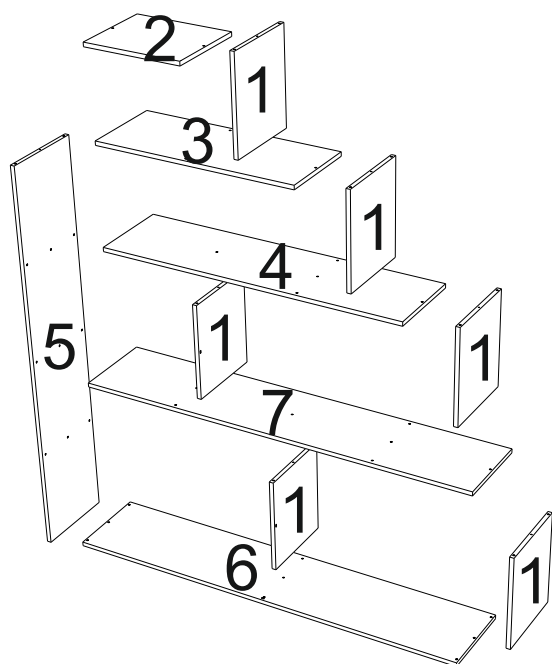
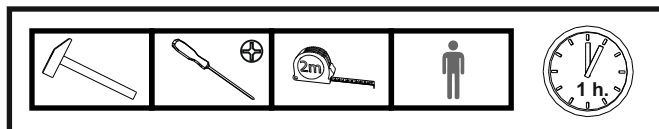
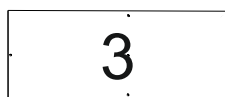

718 x 280 mm

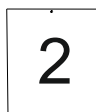

350 x 284 mm



1084 x 280 mm

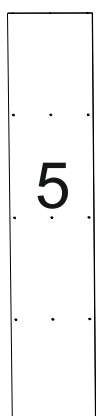

1416 x 282 mm



1450 x 284 mm



1433 x 280 mm

ES

RECOMENDACIONES MONTAJE Y USO

Agrupe y cuente el herraje
Prepare todas las piezas para el montaje del mueble
Tenga preparadas las herramientas para el montaje
Prepare la zona del montaje
Monte el mueble sobre una moqueta para evitar rayar y dañar la superficie del mueble
No fuerce los ensamblajes
Evite colocar el mueble cerca de fuentes de calor
Evite utilizar trapos, paños o productos de limpieza que puedan dañar la superficie del mueble
Mueble para uso doméstico en interior de vivienda

EN

RECOMMENDATIONS FOR ASSEMBLY AND USE

Prepare all the parts of the furniture
Group and count all the hardware
Prepare all the tools for the assembly
Clear and prepare the assembly area.
Do the assembly on a carpet to avoid damaging the surface of the furniture
Avoid forcing the fittings
Avoid placing the Furniture near any heating source
Do not use cloths or cleaning products to avoid damaging the surface of the furniture
Indoor furniture. Suitable for domestic use.

FR

CONSEILS DE MONTAGE CONSEILS POUR L'USAGE

Préparez les différents parts du meuble
Regrouper et compter toute la quincaillerie
Préparez l'outillage nécessaire
Aménagez-vous une area de montage
Faire le montage sur moquette afin de protéger le meuble des rayures
Ne forcer pas le montage
Evitez placer le meuble près des sources de chaleur
Evitez utiliser de chiffons ou des produits de nettoyage pour ne pas rayeur la superficie du meuble
Meuble d'usage domestique pour l'intérieur de maison.

PT

RECOMENDAÇÕES PARA MONTAGEM E USO

Prepare todas as peças para a montagem de móveis
Reagrupar e contar o hardware
Preparar as ferramentas de montagem
Preparar a área de montagem
Montar as peças em um tapete para evitar riscos e danos na superfície dos móveis
Não force as assembleias
Não colocar móveis perto de fontes de calor
Evitar o uso de panos, trapos ou produtos de limpeza que possam riscar o móvel.
Móveis para uso doméstico no interior da casa

IT

CONSIGLI DI INSTALLAZIONE ED USO

Preparare tutti componenti del mobile per il montaggio
Ordinare la ferramenta
Preparare tutti gli attrezzi necessari per il montaggio
Preparare l'area di montaggio
Fare il montaggio su un tappeto per evitare danneggiare le superfici dei mobili
Non forzare i componenti
Evitare posizionare mobile in prossimità di fonti di calore
Non usare panni né detersivi né solventi che possano danneggiare le superficie dei mobili
Mobili per uso domestico all'interno della casa

DE

MONTAGEHINWEISE GEBRAUCHSHINWEISE

Identifizieren Sie die Einzelteile
Überprüfen Sie Die Anzahl der einzelnen Beschlagteile
Legen Sie das notwendige Werkzeug bereit
Bereiten die Montagefläche
Montieren Sie das Möbel auf einem Teppich , sauberen Untergrund
Niemand die verbindungen zu start anziehen
Nicht neben Wärmequellen platzieren
Vermeiden Sie Tücher und keinesfalls scharfe oder ätzende Reinigungsmittel.
Möbel für den Gebrauch im Haus geeignet.

1

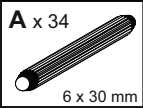
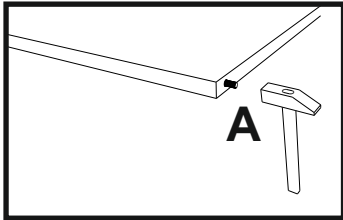
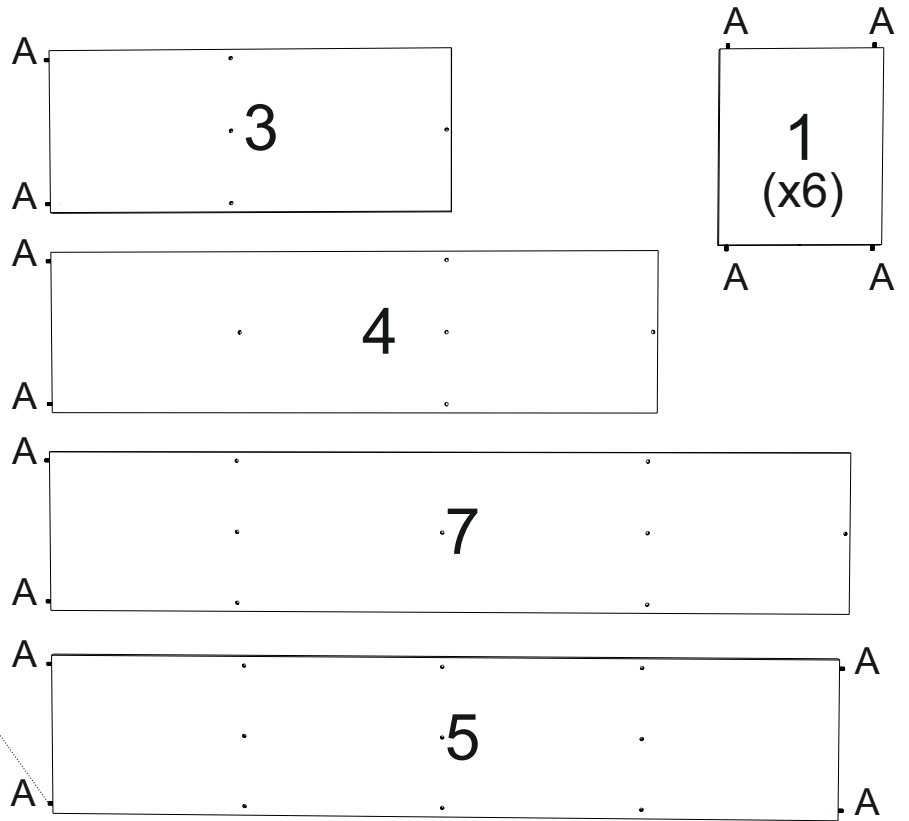

2

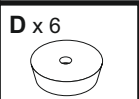
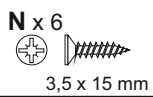
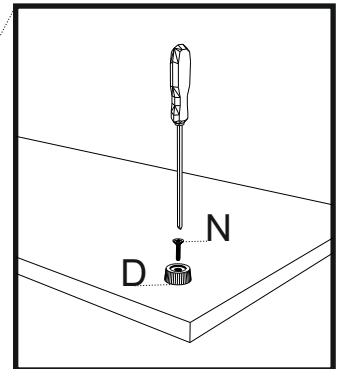
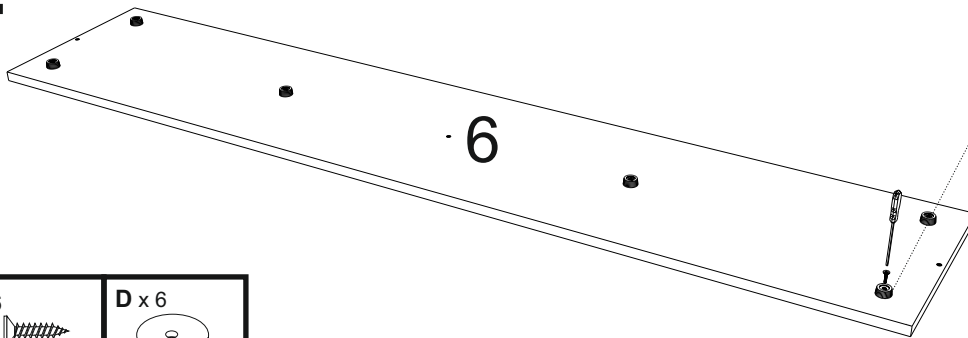

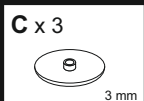
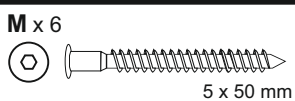
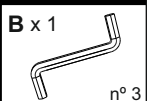
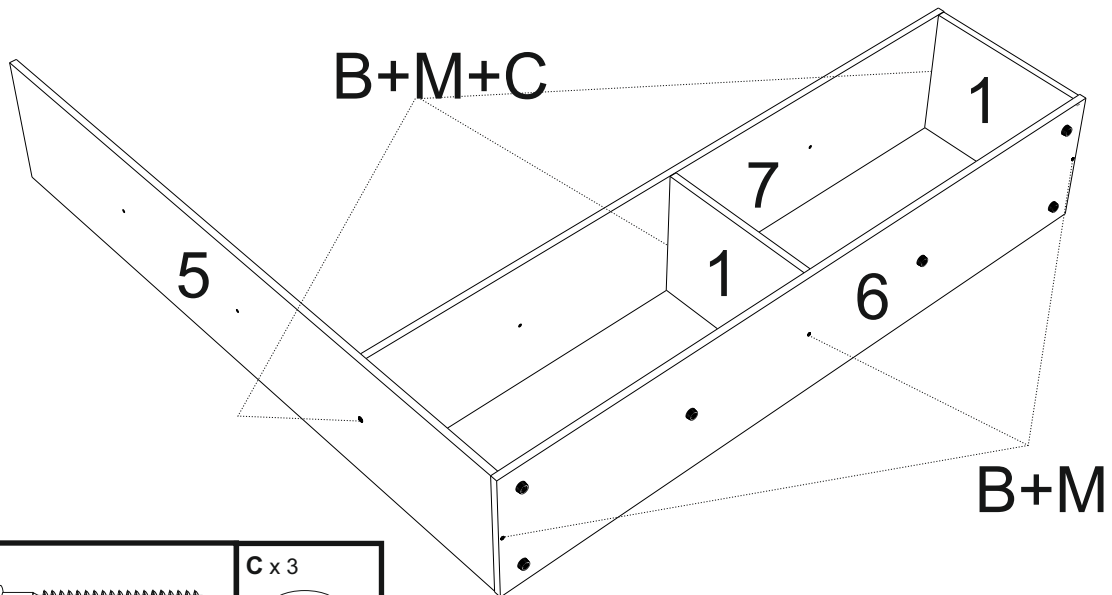

3



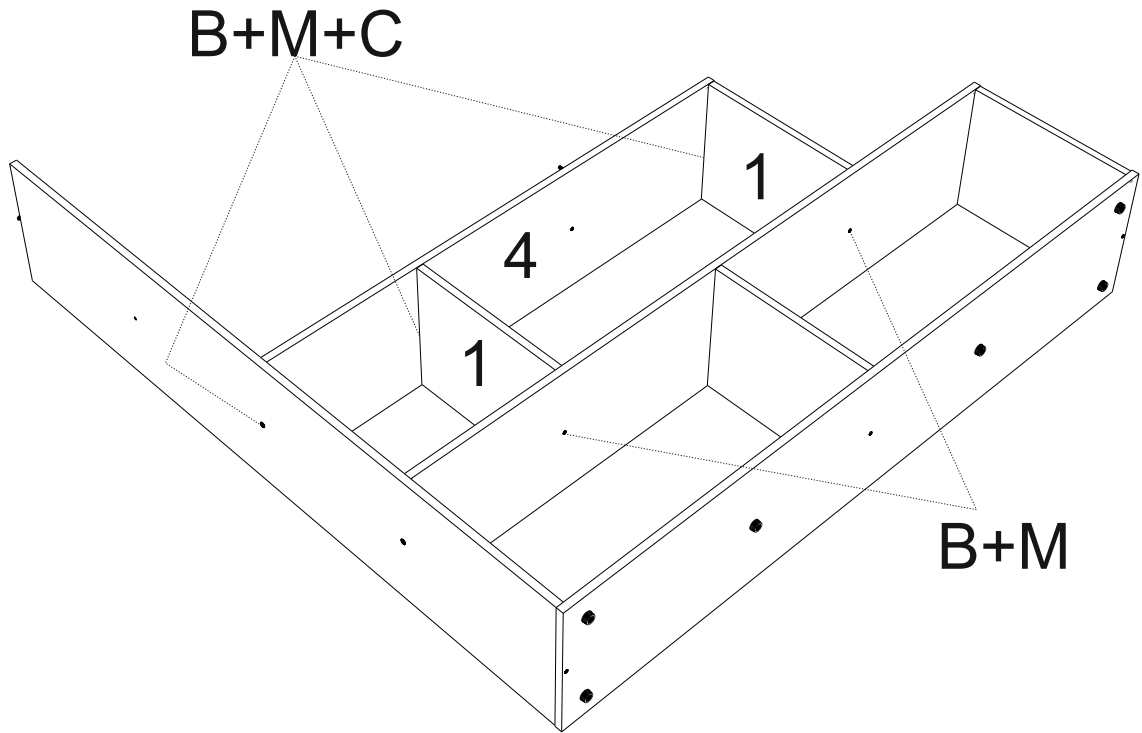

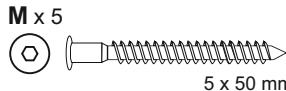

4

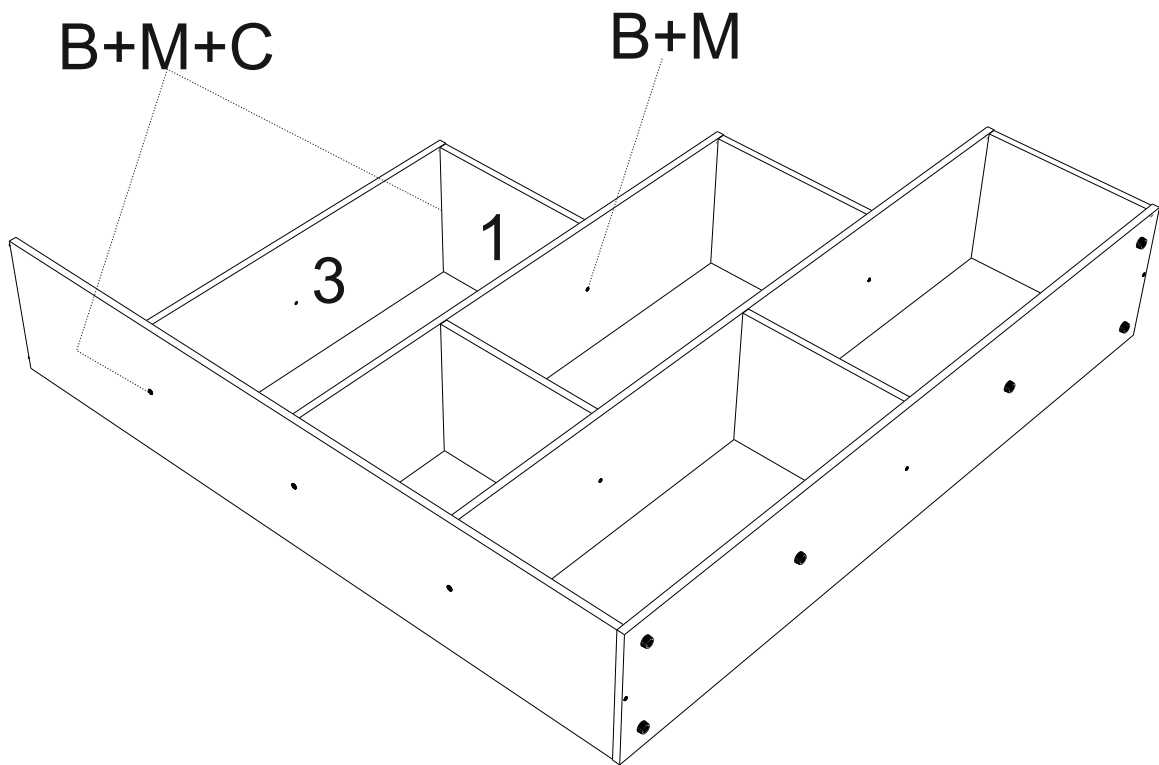

B x 1  n° 3	M x 5  5 x 50 mm	C x 3  3 mm
---	---	--

5

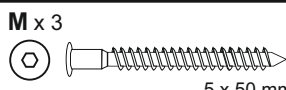

B x 1  n° 3	M x 3  5 x 50 mm	C x 2  3 mm
--	--	---

6

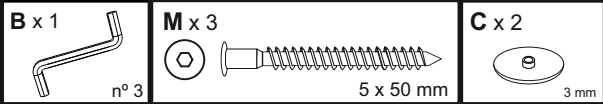
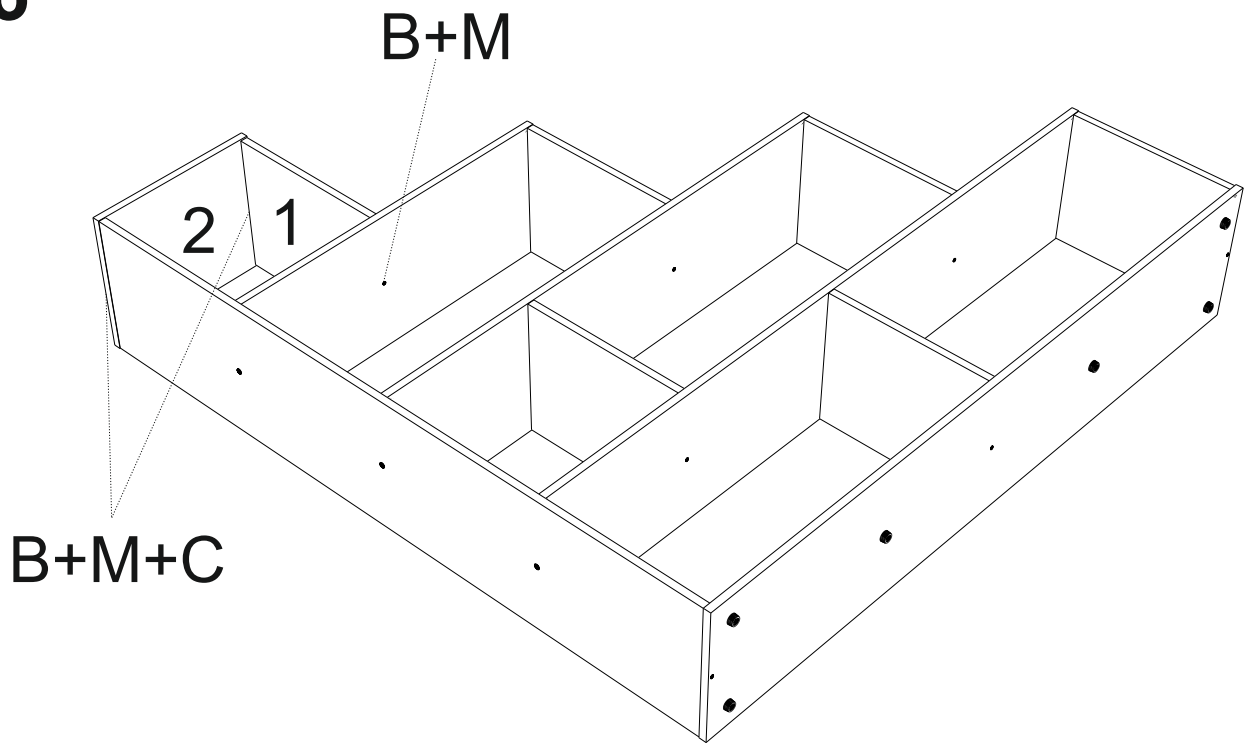

7

